

Project	
Date	
Prepared By	
Order #	11639

Specifications

ELECTRICAL

Input Voltage:

120-277VAC 50/60Hz

Output Voltage: 11~56V

Input Current: 150mA MAX

Output Current:

100~1050mA

Power Fact: .6

Recharge Power:

8W MAX

Standby Power: <0.5W

Red Lead: 3A,90V

White/Black Lead: 100W

MAX

Output Power: 25W MAX

Output Short Protection:

YES

Output Open Protection:

YES

Ambient Temperature:

-20°C ~ 50°C

Ambient Temperature2:

10°C to 50°C LifePO4

Tc MAX: 70°C

Time to Light: 0.3S from

detection of emergency event.

Recharge Time Required:

24 - 48hrs

Battery Type: LifePO4

9.6VDC

Battery Capacity Available:

0.9Ah~6Ah

Emergency Back-up Driver

For use with 120/277V LED Fixtures



ORDER CODE:

11639

FOR USE WITH:

Order Code: 11609 4ft LED Strip
 Fixture 120/277V

Order Code: 11610 8ft LED Strip
 Fixture 120/277V

PRODUCT FEATURES

- + 1050mA output Current max
- + SELV for output voltage <60 V DC
- + Programmable constant current
- + Open Circuit Protection
- + Short Circuit Protection
- + No PCB
- + Sounds Rated A
- + UL / cUL R/C, Class 2
- + FCC Part 15 Class B
- + 5 Years Limited Warranty

WARNINGS

PLEASE READ CAREFULLY AND FOLLOW ALL INSTRUCTION FOR YOUR OWN SAFETY.

- + IMPORTANT: An unswitched AC power source of 100V AC is required.
- + This device is designed for use in fixtures listed for dry and damp locations.
- + CAUTION: Do not let power supply chords touch hot surfaces.
- + CAUTION: Do not mount near gas or electric heaters.
- + CAUTION: Battery is rechargeable LifePO4 type and must be recycled or disposed of properly.
- + Do not use this emergency driver with accessory equipment other than recommended by manufacturer. Failure to follow this may casuse an unsafe condition. Servicing should only be performed by qualified service personnel.
- + Do not use this emergency driver for other than intended use. Equipment should be mounted in locations and at heights where it will not readily be subjected to tampering by unauthorized personnel.

Please consult installation instructions for proper application and use of this fixture.

WIRING DIAGRAMS

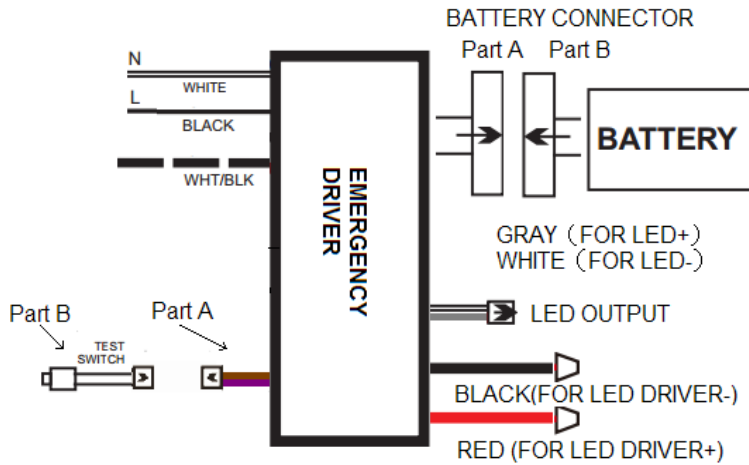

Wire	Length (inches)
WHITE	13.0
BLACK	13.0
WHT/BLK	15.0
Battery Connector (Part A)	1.20
Battery Connector (PartB)	12.0
Test Switch (Part A)	1
Test Switch (Part B)	24.0
Black (for LED Driver-)	21.0
Red (for LED Driver+)	21.0
LED OUTPUT	21.0

LIGHTING LAYOUT

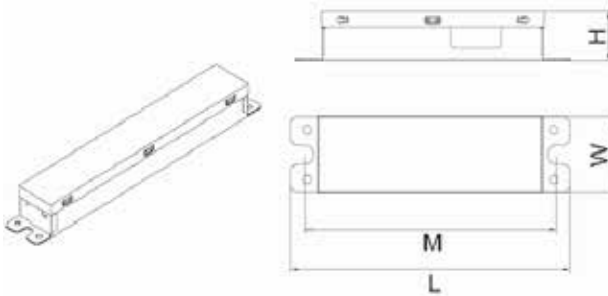

Dimension	Length (inches)
H	1.00
W	1.72
L	5.89
M	5.30

WIRING DIAGRAM (TYP)

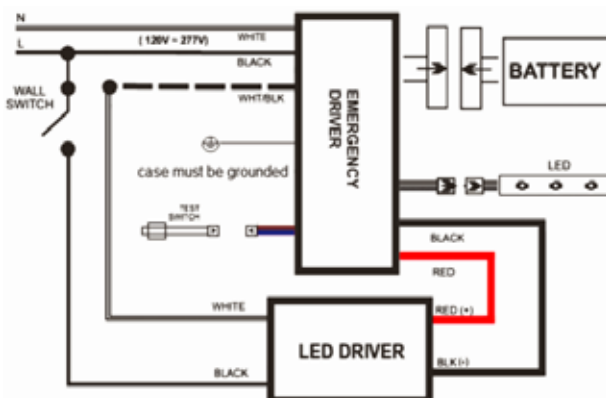

WIRING DIAGRAM (EMERGENCY ONLY)

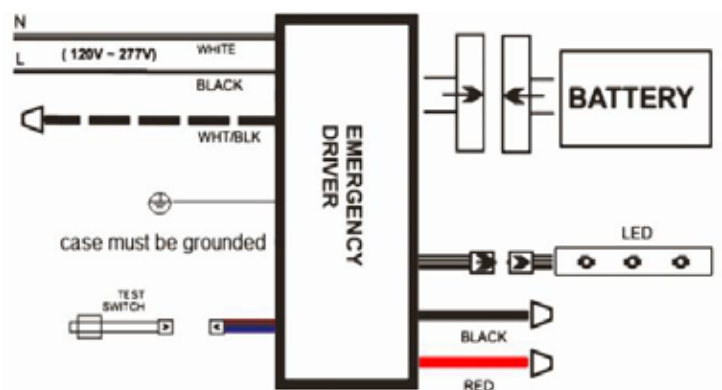

BATTERY CHART

Battery Order Code	Dimension	Battery Type	Capacity	Wattage	Battery Voltage	Re-Charging Time
5W-L	9.37" x 1.10" x 1.12"	LiFePO4	1000mAH	5W	9.6V	24 Hrs
8W-L	9.37" x 1.10" x 1.12"		1500mAH	8W	9.6V	24 Hrs
16W-L	9.37" x 1.22" x 1.20"		3000mAH	16W	9.6V	32 Hrs
25W-L	9.37" x 2.24" x 1.20"		6000mAH	25W	9.6V	48 Hrs
5W-Q	3.62" x 2.70" x 0.98"		1000mAH	5W	9.6V	24 Hrs
8W-Q	3.62" x 2.70" x 0.98"		1500mAH	8W	9.6V	24 Hrs
16W-Q	4.61" x 2.83" x 1.20"		3000mAH	16W	9.6V	32 Hrs
25W-Q	4.61" x 2.83" x 2.38"		6000mAH	25W	9.6V	48 Hrs

BATTERY CASE (L Case)

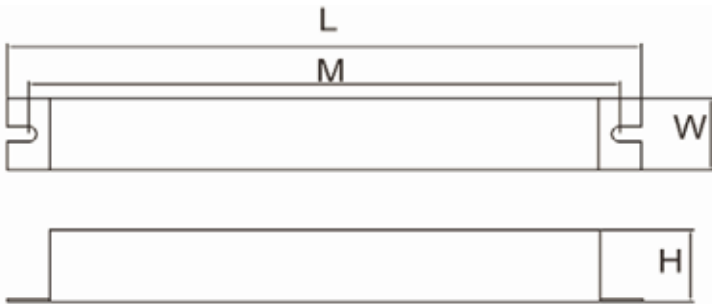

BATTERY CASE (Q Case)

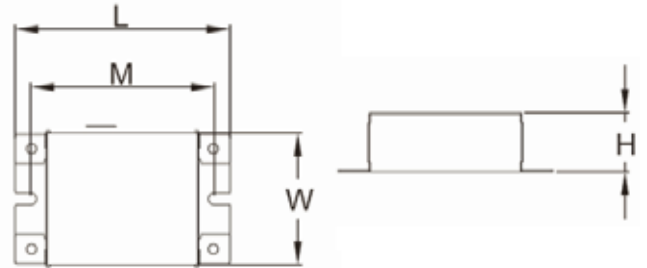

PROGRAM SWITCH

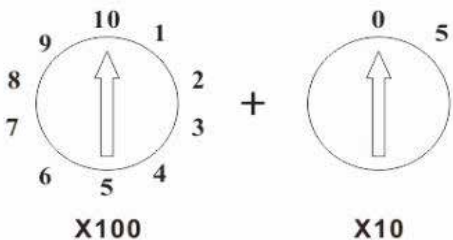
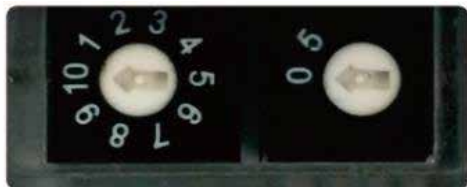

FEATURES

Programmable Constant Current
 +Pre-set by factory
 +Adjust it by yourself

Adjustable Output Current
 +10 ranges
 +50mA per scale